

## BK .P Kogelkraan

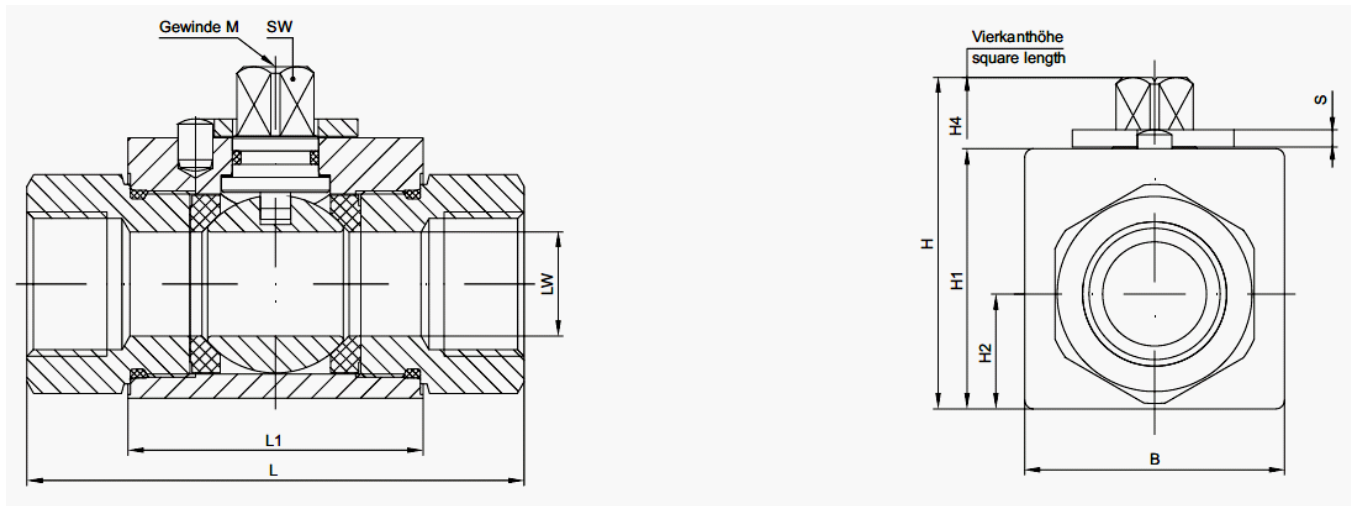

*Huis, kogel uitgevoerd in staal*



## Maten huis

DN mm	LW mm	*PN bar	L1 mm	B mm	H mm	H1 mm	H2 mm	H4 mm	SW mm	M	S mm
4	5	500	36,2	26	43,4	32	12,8	11	9	M5	3
6	6	500	36,2	26	43,4	32	12,8	11	9	M5	3
8	8	500	36,2	26	43,4	32	12,8	11	9	M5	3
10	10	500	43,2	32	49,2	38	16,25	10,9	9	M5	3
13	13	500	48,2	35	51,2	40	17,25	10,9	9	M5	3
16	15	500	48,2	38	61,9	46	18,7	15,5	12	M6	3,5
20	20	400	62,2	49	73,4	57	24,5	16	14	M6	4
25	24	350	66,2	60	76,6	60	26,5	16	14	M6	4

## BK .P Kogelkraan

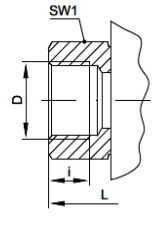
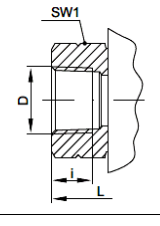
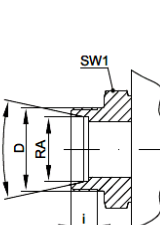
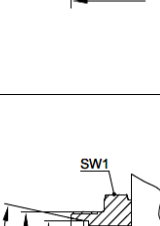
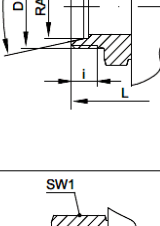

### Mogelijke schoefdraden

Anschlußart/Connection	DN mm	LW mm	D	RA mm	L mm	i mm	SW1 mm	Gew./weight kg
<b>01</b> Rohrgewinde DIN/ISO 228  BSP female thread DIN/ISO 228 	4	5	G 1/8	—	69	8	22	0,35
	6	6	G 1/4	—	69	12	22	0,35
	10	8	G 3/8	—	69	12	22	0,35
	10	10	G 1/2	—	73	12	27	0,5
	13	13	G 3/4	—	85	14	30	0,65
	16	15	G 1/2	—	84	14	32	0,75
	20	20	G 3/4	—	96	16	41	1,5
	25	24	G 1	—	113	18	46	2
	32	24	G 1 1/4	—	121	20	50	2,1
	40	24	G 1 1/2	—	124	22	55	2,1
<b>02</b> NPT-Innengewinde ANSI B 1.20.1  NPT female thread ANSI B 1.20.1 	4	5	1/8-27 NPT	—	69	8	22	0,35
	6	6	1/4-18 NPT	—	69	11,5	22	0,35
	10	10	3/8-18 NPT	—	73	12	27	0,5
	13	13	1/2-14 NPT	—	92	15,5	30	0,65
	20	20	3/4-14 NPT	—	97	16	41	1,5
	25	24	1 - 11,5 NPT	—	113	19	46	2
	32	24	1 1/4-11,5 NPT	—	131	19,5	50	2,1
	40	24	1 1/2-11,5 NPT	—	139	19,5	55	2,3
<b>03</b> Rohrverschraubung DIN 2353 L leichte Reihe For compression fitting DIN 2353 L light series 	4	5	M 12x1,5	6	67	7,5	22	0,3
	6	6	M 14x1,5	8	67	7,5	22	0,3
	8	8	M 16x1,5	10	71	8,5	22	0,3
	10	8	M 18x1,5	12	71	8,5	22	0,3
	10	10	M 18x1,5	12	75	8,5	27	0,5
	13	10	M 22x1,5	15	77	9,5	27	0,5
	13	13	M 22x1,5	15	84	9,5	30	0,6
	16	13	M 26x1,5	18	84	9,5	30	0,6
	16	13	M 22x1,5	15	83	9,5	32	0,75
	16	15	M 26x1,5	18	83	9,5	32	0,75
	20	20	M 30x2	22	102	12	41	1,5
	25	24	M 36x2	28	108	12	46	2
	32	24	M 45x2	35	114	13,5	50	2,1
40	24	M 52x2	42	114	13,5	55	2,2	
<b>04</b> Rohrverschraubung DIN 2353 S schwere Reihe For compression fitting DIN 2353 S heavy series 	4	5	M 14x1,5	6	71,5	9,5	22	0,35
	4	5	M 16x1,5	8	73	9,5	22	0,35
	6	6	M 18x1,5	10	73	9,5	22	0,35
	8	8	M 20x1,5	12	77	9,5	22	0,35
	10	10	M 22x1,5	14	84	11,5	27	0,5
	13	13	M 24x1,5	16	87	11,5	30	0,6
	16	13	M 30x2	20	91	13,5	30	0,65
	16	13	M 24x1,5	16	87	11,5	32	0,75
	16	15	M 30x2	20	91	13,5	32	0,75
	20	20	M 36x2	25	110	15	41	1,5
	25	24	M 42x2	30	120	17	46	2,1
	32	24	M 52x2	38	125	19	55	2,3
<b>31</b> UN/UNF-Einschraubgewinde SAE J514  UN/UNF female thread SAE J514 	6	6	7/16-20 UNF-2B	—	69	11,5	22	0,35
	10	10	9/16-18 UNF-2B	—	75	12,7	27	0,5
	13	13	3/4-16 UNF-2B	—	85	14,3	30	0,65
	16	15	7/8-14 UNF-2B	—	84	16,7	32	0,75
	20	20	1 1/16-12 UN-2B	—	96	19	41	1,5
	25	24	1 9/16-12 UN-2B	—	114	19	46	2
	32	24	1 5/8-12 UN-2B	—	122	19	50	2,2
	40	24	1 7/8-12 UN-2B	—	128	19	60	2,4

## DBK .P 3-weg kogelkraan

Huis en kogel uitgevoerd in staal



L-Bohrung 0°-90°  
L-bore  
Best-Nr./order-code: L

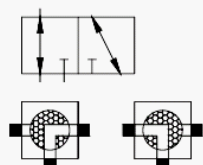

L-Bohrung, pos. Überdeckung 0°-90°-180°  
L-bore positive overlap  
Best-Nr./order-code: P

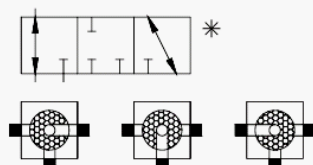

T-Bohrung 0°-90°  
T-bore  
Best-Nr./order-code: T

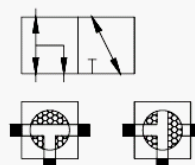

T-Bohrung 0°-90°-180°  
T-bore  
Best-Nr./order-code: T180°

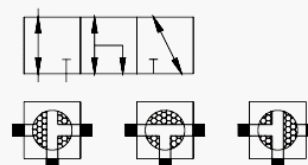

DN mm	*PN bar	L1 mm	B mm	H mm	H1 mm	H2 mm	H4 mm	M	S mm	SW mm
4	400	36	26	43,5	32	13	10,9	M5	3	9
6	400	36	26	43,5	32	13	10,9	M5	3	9
8	400	36	26	43,5	32	13	10,9	M5	3	9
10	400	43	32	49	38	16,5	10,9	M5	3	9
13	350	48	35	51	40	17,5	10,9	M5	3	9
16	350	48	38	62	46	19	15,5	M6	3,5	12
20	350	61	49	73	57	24,5	16	M6	4	14
25	350	65	60	76	60	26,5	16	M6	4	14
32	350	80	76	104	84	38	18,5	M8	5	17
40	350	85	83	111	92	41,5	18,5	M8	5	17
50	350	100	100	130	111	50	18,5	M8	5	17

## DBK .P 3-weg kogelkraan

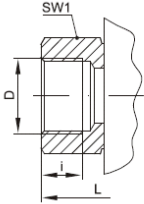
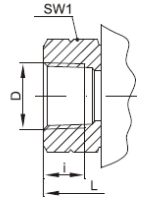
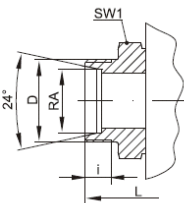
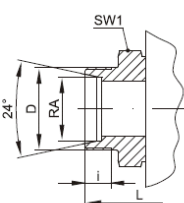
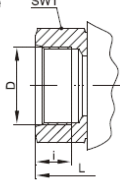
Anschlußart/Connection	DN mm	LW mm	D	RA mm	L mm	L10 mm	i mm	SW1 mm	Gew./weight kg
<b>01</b> Rohrgewinde DIN/ISO 228  BSP female thread DIN/ISO 228  	4	5	G ¼	—	69	32	8	22	0,4
	6	6	G ¼	—	69	32	12	22	0,4
	10	7	G ¾	—	69	37	12	22	0,4
	10	9	G ¾	—	73	35	12	27	0,55
	13	11,5	G ½	—	85	37	14	30	0,7
	16	14	G ½	—	84	38	14	32	0,8
	20	18	G ¾	—	96	47	16	41	1,55
	24	22	G 1	—	113	55	18	46	2,1
	32	22	G 1 ¼	—	121	55	20	50	2,2
	40	22	G 1 ½	—	124	56	22	55	2,4
	32	30	G 1 ¼	—	110	70	20	60	3,4
	40	35	G 1 ½	—	120	74	22	70	4,2
	50	44	G 2	—	140	85	24	85	6,1
<b>02</b> NPT-Innengewinde ANSI B 1.20.1  NPT female thread ANSI B 1.20.1  	4	5	¼-27 NPT	—	69	32	8	22	0,4
	6	6	¼-18 NPT	—	69	32	11,5	22	0,4
	10	9	¾-18 NPT	—	73	35	12	27	0,55
	16	11,5	½-14 NPT	—	92	42	15,5	30	0,7
	20	18	¾-14 NPT	—	97	47	16	41	1,55
	25	22	1 - 11,5 NPT	—	113	55	19	46	2,1
	32	22	1 ¼-11,5 NPT	—	131	55	19,5	50	2,2
	40	22	1 ½-11,5 NPT	—	139	74	19,5	55	2,5
	32	30	1 ¼-11,5 NPT	—	115	70	19,5	60	3,4
	40	35	1 ½-11,5 NPT	—	135	75	19,5	70	4,2
	50	44	2 - 11,5 NPT	—	140	85	20	85	6,2
<b>03</b> Rohrverschraubung DIN 2353 L leichte Reihe For compression fitting DIN 2353 L light series  	4	5	M 12x1,5	6	67	32	7,5	22	0,35
	6	6	M 14x1,5	8	67	32	7,5	22	0,35
	8	7	M 16x1,5	10	71	32	8,5	22	0,35
	10	7	M 18x1,5	12	71	32	8,5	22	0,35
	10	9	M 18x1,5	12	75	35	8,5	27	0,55
	13	9	M 22x1,5	15	77	40	9,5	27	0,55
	13	11,5	M 22x1,5	15	84	42	9,5	30	0,65
	16	11,5	M 26x1,5	18	84	42	9,5	30	0,65
	16	14	M 26x1,5	18	83	43	9,5	32	0,8
	20	18	M 30x2	22	102	47	12	41	1,6
	25	22	M 36x2	28	108	55	12	46	2,1
	32	22	M 45x2	35	114	60	13,5	50	2,2
	40	22	M 52x2	42	114	60	13,5	55	2,4
32	30	M 45x2	35	128	69	13,5	60	3,2	
40	35	M 52x2	42	133	74	13,5	70	4	
<b>04</b> Rohrverschraubung DIN 2353 S schwere Reihe For compression fitting DIN 2353 S heavy series  	4	5	M 14x1,5	6	71,5	32	9,5	22	0,4
	4	5	M 16x1,5	8	73	32	9,5	22	0,4
	6	6	M 18x1,5	10	73	32	9,5	22	0,4
	8	7	M 20x1,5	12	77	32	9,5	22	0,4
	10	9	M 22x1,5	14	84	35	11,5	27	0,55
	13	11,5	M 24x1,5	16	87	42	11,5	30	0,65
	16	11,5	M 30x2	20	91	42	13,5	30	0,7
	16	14	M 30x2	20	91	43	13	32	0,8
	20	18	M 36x2	25	110	47	15	41	1,6
	25	22	M 42x2	30	120	55	17	46	2,1
	32	30	M 52x2	38	140	74	19	50	3,2
	<b>31</b> UN/UNF-Einschraubgewinde SAE J514  UN/UNF female thread SAE J514  	6	6	¼-20 UNF-2B	—	69	32	11,5	22
10		10	¾-18 UNF-2B	—	75	35	12,7	27	0,55
13		13	¾-16 UNF-2B	—	85	37	14,3	30	0,7
20		20	1 ¼-12 UN-2B	—	96	50	19	41	1,55
25		24	1 ¾-12 UN-2B	—	114	60	19	46	2,1
32		32	1 ½-12 UN-2B	—	110	70	19	60	3,4
40		38	1 ¾-12 UN-2B	—	117	74	19	70	4,2
50		48	2 ½-12 UN-2B	—	140	85	19	80	6,1

## DDF3V..A

### 3-weg kogelkraan

Uitgevoerd in gegoten staal

Maten	02	03	04	05	07
Max. druk bar	315	280	250	250	200
Max. flow l/min	60	90	120	180	280

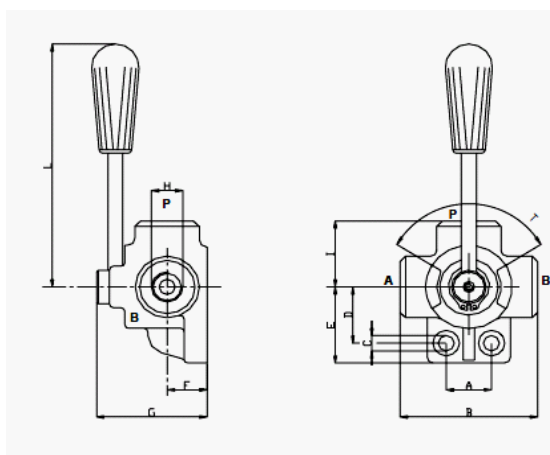
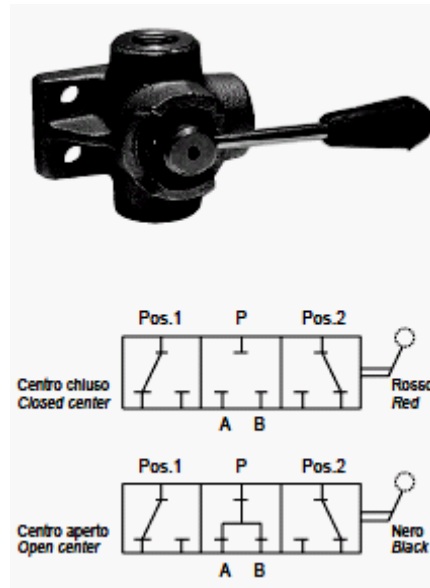

Maat	A	B	C	D	E	F	G	H	I	L	T°	GEWICHT
												KG
02	24	73	8,5	31	42	21	62	3/8	36	125	100	0,87
03	30	85	11	36	53	24	70	1/2	43	125	100	1,45
04	32	91	11	41	58	28	80	3/4	47	125	100	1,84
05	32	98	11	50	64	31,5	90	1	51	160	100	2,51
07	42	130	11	64	80	44	115	1 1/2	65	160	100	6,10

**TL*****Aster kogelkraan maximale werkdruk tot 25 bar***

De Aster kogelafsluiter is ontworpen voor veiligheid en kwaliteit, rekening houdend met de vraag naar een scherpe prijs.

Toepassing: Industrie, land- en tuinbouw, C.V., drinkwater, hydrauliek en pneumatiek.

Afdichtingen: Kogel: PTFE.  
Kogelas: 2 x VITON O-ring + 1 x vlakke PTFE drukring.

Materiaal: Huis: Warm geperst vernikkeld messing (CuZn40PB2) UNI5705-65.  
Kogel: Messing, hardverchromd (CuZn40PB2) UNI5705-65.  
Kogelas: Messing (CuZn40PB2) UNI5705-65.  
Handel: Gespoten aluminium, polyurethaan gecoat/blauw UNI5067.  
Borgmoer: Verzinkt staal.  
Schroefdraad: BSP.

Nummer	LENGTE mm	HOOGTE mm	SW	DRUK bar
TL 1/4	37	54	8	25
TL 3/8	42	54	10	22
TL 1/2	50	61	15	18
TL 3/4	58	72	20	18
TL 1	69	80	25	14
TL 1 1/4	81	99	32	10
TL 1 1/2	93	111	40	10
TL 2	110	135	50	8
TL 2 1/2	133	172	65	8
TL 3	156	195	80	4
TL 4	193	226	100	4